

# NEW IUSSO<sup>®</sup>

The orangery-style roof system that adds style and value to your conservatories

**eurocell**<sup>®</sup>  
All together better



**lusso**<sup>®</sup>

## STYLISH CONSERVATORIES WITH AN EXTRA TOUCH OF ELEGANCE ON TOP

The orangery-style conservatory is the latest look for homeowners.

With its traditional Victorian or Edwardian lines and all that extra light, it's easy to see why.

But what if they want all the country house appeal of a genuine orangery, but their budget won't stretch to the real thing?

That's easy. Offer them our Lusso conservatory roof. An internal pelmet and rooflight system that gives you everything you need to finish off their new conservatory, or refresh the look of an existing one, in true style.

### **A modern take on traditional roof design**

With Lusso, you can create the look of an orangery. But without the extra building work or added cost of making sure the conservatory can support a 'fuller' roof.

That's because Lusso looks like the real thing, right down to its deep perimeter, lantern roof and period details. But it's a lightweight, prefabricated system that's quick and easy to install.

## WHY CHOOSE A LUSO CONSERVATORY ROOF?



**Easy to install**



**Fast, accurate  
installation and  
construction**



**Low material and  
labour costs**



**Better draft  
proofing than  
conventional roofs**



**Pitch range  
15-35 degrees**



**Cosy internal living  
environment**



**More natural light  
than lantern roofs**



**10-year  
manufacturer  
product guarantee**

### More sales opportunities

Lusso lets you match your conservatories to a wider range of house styles with colour-matched trims and accessories, a choice of lighting kits and roofpitch pitches from 15° to 35°. More choice for your customers. More business for you.

### Quick and easy to install

Lusso's clever box-section pelmet means there's minimal need for plastering required. Just clip interior trim and cladding direct to the aluminium frame. Faster, cleaner and less hassle than traditional orangeries.

### Service and support

Get expert advice from our Conservatory roofs customer care team. Just call **01773 842 346** for help with installation, or any other questions.



**lusso**<sup>®</sup>

## HELPING YOUR CUSTOMERS GET THE CONSERVATORY ROOF THEY WANT

Although it's most common on Edwardian style conservatories, the double hipped lantern roof looks great on our Victorian and P-shaped designs too. So now you've got even more options to offer householders looking to add extra style and space to their home.

Because of Lusso's lightweight frame and fast installation, it's just as easy to retrofit an orangery style internal pelmet to an existing conservatory.

But whether you've designed Lusso in from the start or using it to improve the look of a conservatory that's beginning to show its age, the benefit for your customers is the same:

A genuine extra room in the house they can use the whole year round. Loads more natural daylight from a clear glass lantern roof. And a relaxing atmosphere created by concealed LED pelmet lighting they can enjoy into the evening.

### Putting it all together

Like every Eurocell system, Lusso is designed to look good and perform even better. But just as important, it's designed so you can install a quality finished product quickly, easily and with minimum cost.

There's an 'intelligently-designed' box section pelmet that houses up or down LED lighting in stainless steel, aluminium, chrome or black.

All the interior trim and cladding clips neatly onto the aluminium frame, giving a clean look with minimal finishing requirements. And a thermal break in the ring beam protects against heat loss so you don't have to think about extra insulation.



### Highline Gutter

Create the look of an orangery style conservatory with our quality highline gutter and decorative corner castings.



### Internal Pelmet

Let the homeowner enjoy more natural daylight than from a clear glass lantern roof, plus a relaxing atmosphere created by concealed LED pelmet lighting in the evening.



# PREMIUM QUALITY HIGHLINE GUTTER



TWO INTERNAL  
PELMET SIZES  
LUSSO AND  
LUSSO LIGHT

**lusso**<sup>®</sup>

AN EVEN WIDER CHOICE FOR  
CONSERVATORY INSTALLERS

Lusso is just one in a wide range of Eurocell conservatory systems and designs.

All our conservatory frames, roofs, profiles, finials and finishes are compatible, so you don't have to look anywhere else to create exactly the conservatory your customers are looking for. Or for the help and advice you need to erect it with the minimum of hassle.

And because Eurocell conservatories are highly energy efficient, every job exceeds the latest energy-efficiency standards and every customer gets a room they can use, the whole year round.

## **Classic style**

Our bespoke conservatory range covers classic and contemporary styles including Victorian, Edwardian, P-style and gable-ended. And now, with Lusso, orangery designs too.

Lusso in timeless white delivers classic style, with special interior colours available on request.

## **Guaranteed peace of mind**

Whichever Eurocell conservatory roof system you choose, you will still receive our 10-year manufacturer guarantee, giving your customers peace of mind.

# NATURAL DAYLIGHT

FROM A CLEAR GLASS ROOF

VARIABLE  
**15-35°** PITCH

# HOMELY

INTERNAL ENVIRONMENT

## LUSSO ROOF TYPES AVAILABLE

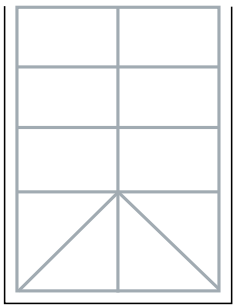

Edwardian

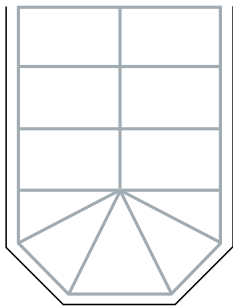

3 Facet Victorian

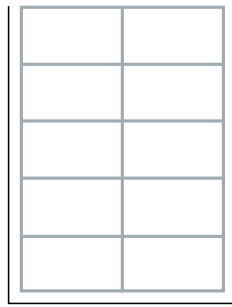

Gable Ended

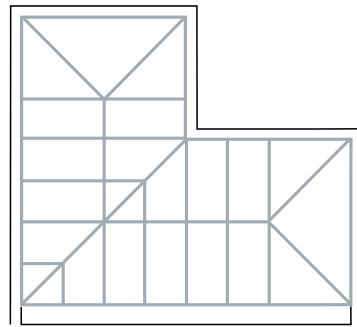

P-Shaped Edwardian

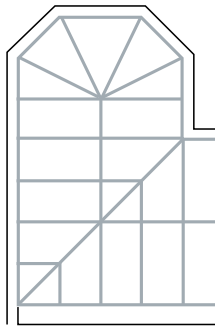

P-Shaped Victorian



lusso®

THE FULL ORANGERY EXPERIENCE WITH HIGHLINE GUTTER  
AND LARGE HOMELY PELMET

## LUSSO INTERNAL PELMET

Let the homeowner enjoy more natural daylight than from a clear glass lantern roof, plus a relaxing atmosphere created by a deep pelmet dimension and concealed LED pelmet lighting in the evening.

## LUSSO HIGHLINE GUTTER

Create the look of an orangery style conservatory with our quality highline gutter and decorative corner castings.







**LUSO** LIGHT

## SLIMMER PELMET FOR INCREASED INTERNAL LIGHT

The intelligently-designed continuous box-section around the roof avoids the needs for plastering and simply allows the trims and cladding (all perfectly colour-matched to the orangery-style roof) to be fitted to the aluminium fascia mounted on brackets. As well as avoiding installers having to factor in specialist trades to carry out plastering, this design significantly reduces the amount of time needed to complete the project.

With the ability to incorporate subtle lighting within the roof perimeter and a full range of perfectly colour-matched trims and accessories, it provides customers with plenty of scope for creating a lasting impression. Lusso is available to both bar length and kit customers.



### **Complementary products:**

HD LED downlight kits are available (roof kit customers only). Fitting kits are stainless steel as standard, with aluminium, chrome and black colour options available on request.

# TECHNICAL INFORMATION

## LUSSO CONSERVATORY ROOFING

### LUSSO HIGHLINE GUTTER COMPONENTS

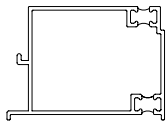

Highline gutter adaptor  
**CRS 8577A**

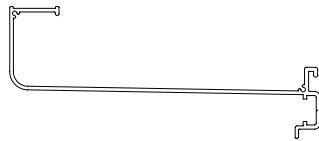

Highline gutter base  
**CRS 8578A**

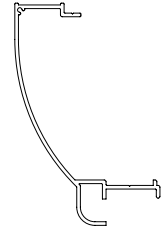

Highline gutter  
**CRS 8579A**

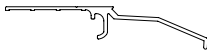

Gable support cill  
**CRS 8548A**



Eurogroove cover  
**EWS 112**

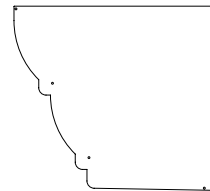

End plate  
**CRS 8574A**

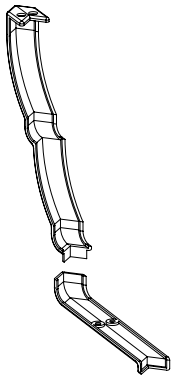

90° corner casting  
**CRS 8570A**

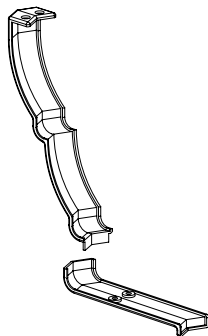

135° corner casting  
**CRS 8571A**

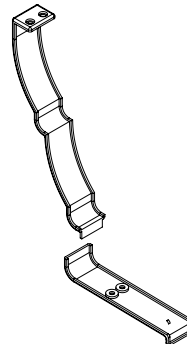

Inline joint casting  
**CRS 8572A**

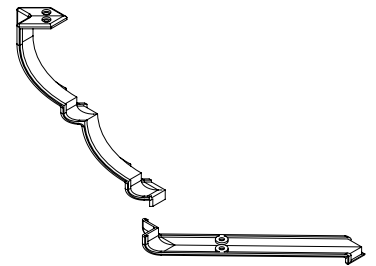

Internal 90° corner casting  
**CRS 8573A**

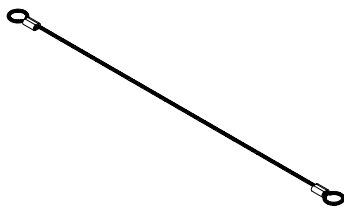

Tie wire  
**CRS 8679S**

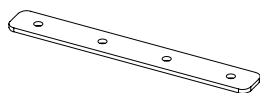

Straight cleat  
**CRS 8671S**

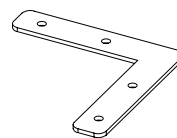

90° corner cleat  
**CRS 8672S**

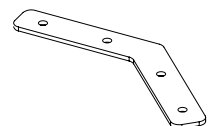

135° corner cleat  
**CRS 8673S**

## LUSSO INTERNAL PELMET

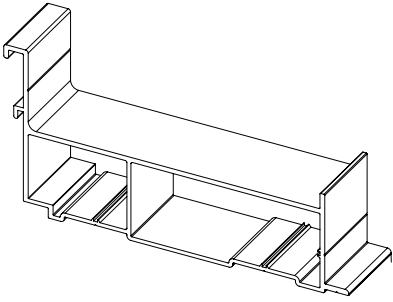

Internal pelmet bracket  
**CRS 8545A**



Internal pelmet rafter bracket  
**CRS 8546A**

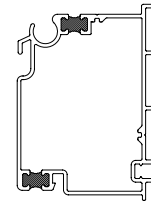

Thermally broken ring beam  
**CRS 8547A**

## LUSSO LIGHT INTERNAL PELMET

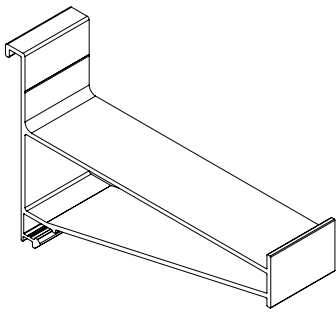

Faux orangery bracket  
**CRS 8575A**



Faux orangery internal trim  
**CRS 8576A**



Ring orangery trim  
**CRS 8075**



Ring beam internal trim  
**CRS 8548**

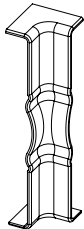

Internal corner moulding  
**CRS 8256**

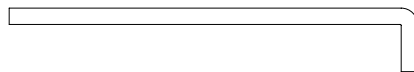

225mm capping board  
**CB 225**

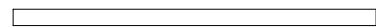

200mm utility board  
**UB 200**



*All together better*

For more information about **lusso**® conservatory roofing from Eurocell, call our customer care team on **01773 842 346**, or visit **eurocell.co.uk/lusso**

Eurocell plc, Fairbrook House, Clover Nook Road, Alfreton, Derbyshire DE55 4RF



**eurocell.co.uk**